



## GRAND ENTRY STEP DETAILS - GENERAL TABLE OF CONTENTS

### GRAND ENTRY STEP DETAILS

<b>MODERN ENTRY STEPS</b>	<b>PAGE #</b>
Modern Entry Step - General Details	1
Modern Entry Step Details	2
Modern Entry Step Riser Block Details	3
<b>CLASSIC ENTRY STEPS</b>	
Classic Entry Step - General Details	4
Classic Entry Step Details	5
Classic Entry Step Outside Radius	6
Classic Entry Step Inside Radius	7
<b>SONORASTONE<sup>®</sup> ENTRY STEPS</b>	
Sonorastone <sup>®</sup> Entry Step - General Details	8
Sonorastone <sup>®</sup> Entry Step Radius Piece Details	9
Sonorastone <sup>®</sup> Entry Step Outside Radius	10

Visit us at our website [www.stepstoneinc.com](http://www.stepstoneinc.com)





## MODERN ENTRY STEP DETAILS

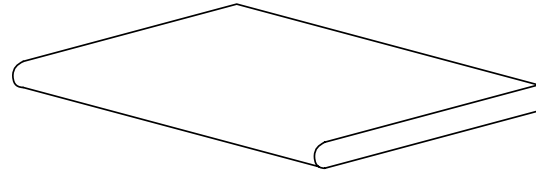

**24" STRAIGHT**

BULLNOSE: 1 SIDE  
THICKNESS: 2"  
SIZE: 18" x 24"

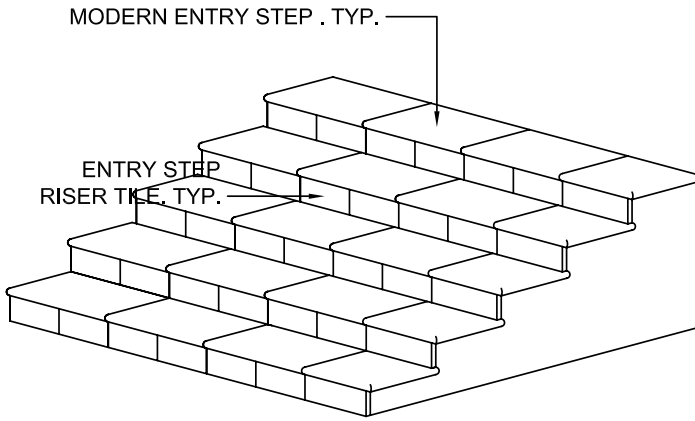

**ISOMETRIC VIEW**

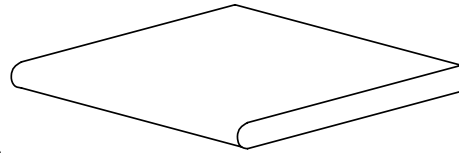

**18" STRAIGHT**

BULLNOSE: 1 SIDE  
THICKNESS: 2"  
SIZE: 18" x 18"

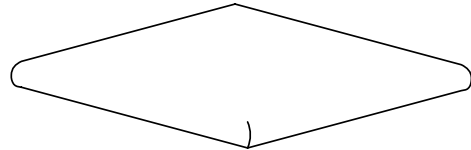

**CORNER**

BULLNOSE: 2 SIDES  
THICKNESS: 2"  
SIZE: 18" x 18"  
JOINS W/ STRAIGHT  
PIECES TO FORM  
OUTSIDE CORNERS.

**NOTES:**

1. PRECAST UNITS ARE INDIVIDUALLY HAND CAST. LENGTHS ARE APPROXIMATE. SOME VARIATIONS ARE EXPECTED.
2. INSTALLATION TO BE COMPLETED IN ACCORDANCE WITH GENERALLY ACCEPTED MASONRY PRACTICE.
3. STIPPLE FINISH ON TOP AND NOSE. SANDBLAST FINISH AVAILABLE.
4. PRECAST UNITS MAY BE CUT TO FIT FIELD CONDITIONS.

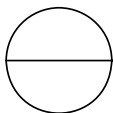

## MODERN ENTRY STEP - GENERAL DETAILS

SCALE: N.T.S.





## MODERN ENTRY STEP DETAILS

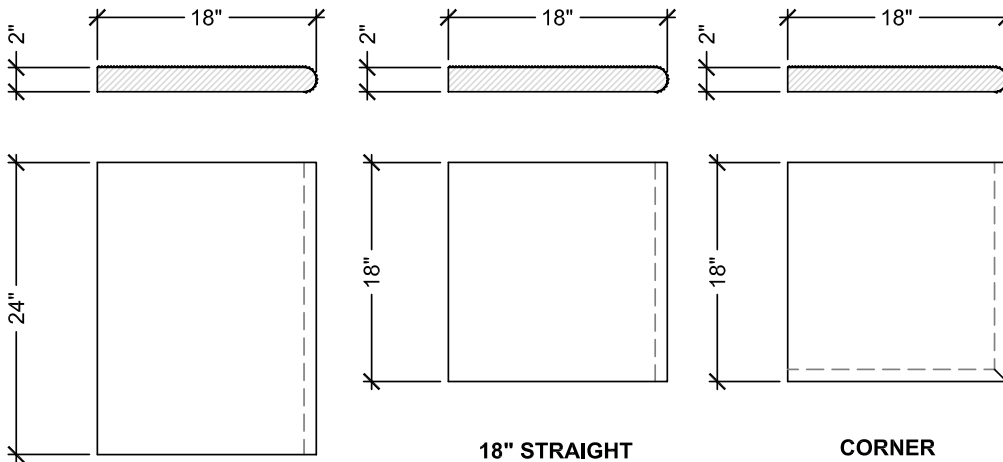
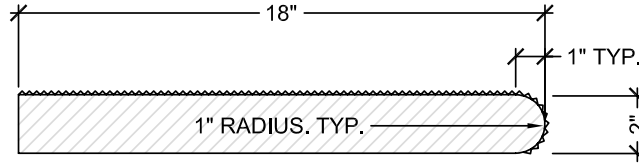

**24" STRAIGHT**

BULLNOSE: 1 SIDE  
THICKNESS: 2"  
SIZE: 18" x 24"

**18" STRAIGHT**

BULLNOSE: 1 SIDE  
THICKNESS: 2"  
SIZE: 18" x 18"

**CORNER**

BULLNOSE: 2 SIDES  
THICKNESS: 2"  
SIZE: 18" x 18"  
JOINS W/ STRAIGHT  
PIECES TO FORM  
OUTSIDE CORNERS.

**NOTES:**

1. PRECAST UNITS ARE INDIVIDUALLY HAND CAST. LENGTHS ARE APPROXIMATE. SOME VARIATIONS ARE EXPECTED.
2. INSTALLATION TO BE COMPLETED IN ACCORDANCE WITH GENERALLY ACCEPTED MASONRY PRACTICE.
3. STIPPLE FINISH ON TOP AND NOSE. SANDBLAST FINISH AVAILABLE.
4. PRECAST UNITS MAY BE CUT TO FIT FIELD CONDITIONS.

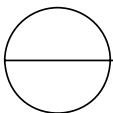

## MODERN ENTRY STEP DETAILS

SCALE: N.T.S.





## MODERN ENTRY STEP DETAILS

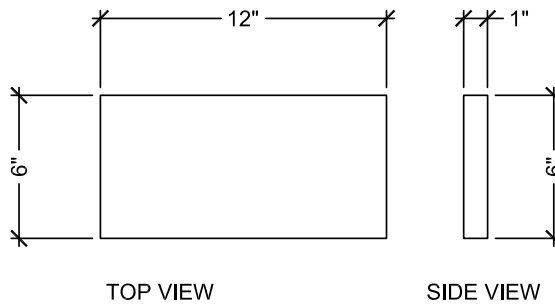
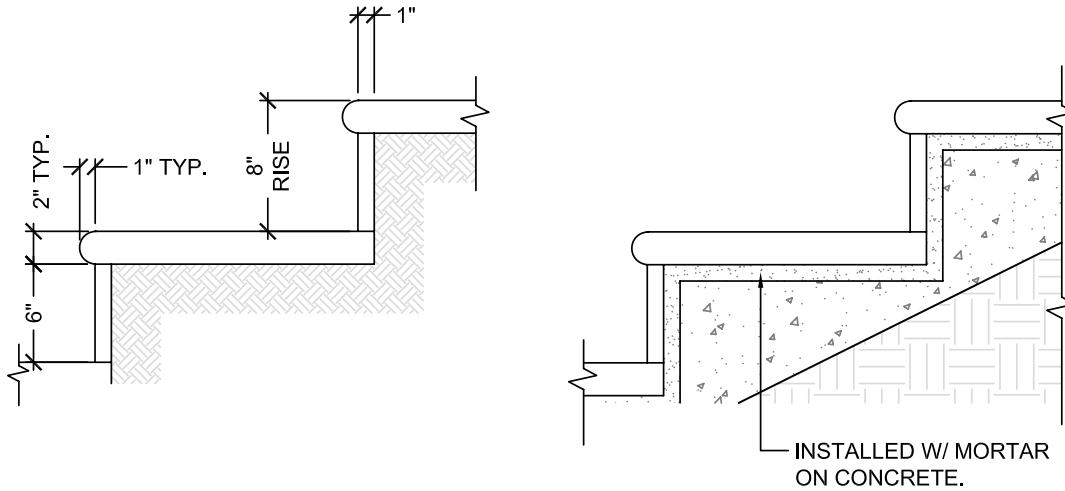

ENTRY STEP RISER TILE

**NOTES:**

1. PRECAST UNITS ARE INDIVIDUALLY HAND CAST. LENGTHS ARE APPROXIMATE. SOME VARIATIONS ARE EXPECTED.
2. INSTALLATION TO BE COMPLETED IN ACCORDANCE WITH GENERALLY ACCEPTED MASONRY PRACTICE.
3. STIPPLE FINISH ON TOP AND NOSE. SANDBLAST FINISH AVAILABLE.
4. PRECAST UNITS MAY BE CUT TO FIT FIELD CONDITIONS.

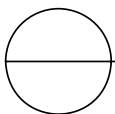

## MODERN ENTRY STEP RISER BLOCK DETAILS

SCALE: N.T.S.





## CLASSIC ENTRY STEP DETAILS

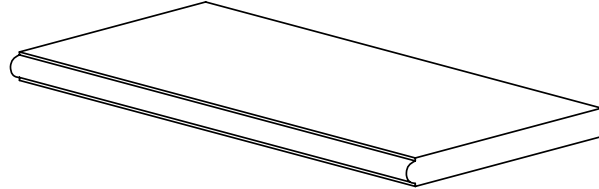

**STRAIGHT**

BULLNOSE: 1 SIDE  
THICKNESS: 2- $\frac{1}{2}$ "  
SIZE: 14" x 24"

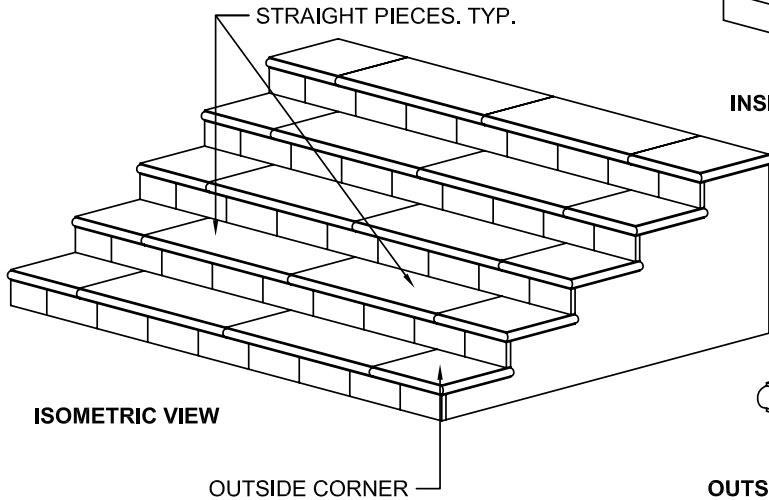

**ISOMETRIC VIEW**

OUTSIDE CORNER

STRAIGHT PIECES. TYP.

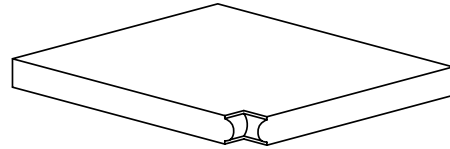

**INSIDE CORNER**

BULLNOSE: 1 SIDE  
THICKNESS: 2- $\frac{1}{2}$ "  
SIZE: 16" x 16"  
JOINS W/ STRAIGHT  
PIECES TO FORM  
INSIDE CORNERS.

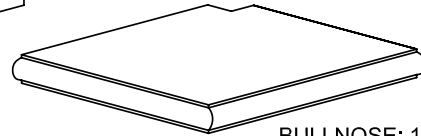

**OUTSIDE CORNER**

BULLNOSE: 1 SIDE  
THICKNESS: 2- $\frac{1}{2}$ "  
SIZE: 16" x 16"  
JOINS W/ STRAIGHT  
PIECES TO FORM  
OUTSIDE CORNERS.

**NOTES:**

1. PRECAST UNITS ARE INDIVIDUALLY HAND CAST. LENGTHS ARE APPROXIMATE. SOME VARIATIONS ARE EXPECTED.
2. INSTALLATION TO BE COMPLETED IN ACCORDANCE WITH GENERALLY ACCEPTED MASONRY PRACTICE.
3. STIPPLE FINISH ON TOP WITH SMOOTH BULLNOSE. SANDBLAST FINISH AVAILABLE.
4. PRECAST UNITS MAY BE CUT TO FIT FIELD CONDITIONS.

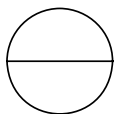

## CLASSIC ENTRY STEP - GENERAL DETAILS

SCALE: N.T.S.





## CLASSIC ENTRY STEP DETAILS

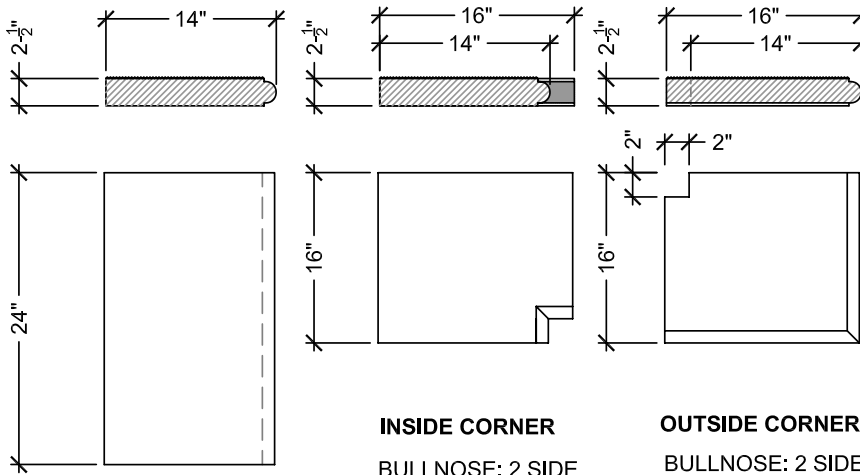
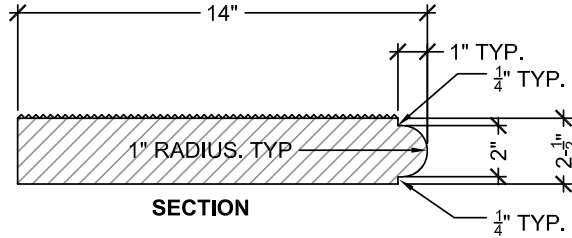

**STRAIGHT**  
BULLNOSE: 1 SIDE  
THICKNESS: 2- $\frac{1}{2}$ "  
SIZE: 14" x 24"

**INSIDE CORNER**  
BULLNOSE: 2 SIDE  
THICKNESS: 2- $\frac{1}{2}$ "  
SIZE: 16" x 16"  
JOINS W/ STRAIGHT  
PIECES TO FORM  
INSIDE CORNERS.

**OUTSIDE CORNER**  
BULLNOSE: 2 SIDE  
THICKNESS: 2- $\frac{1}{2}$ "  
SIZE: 16" x 16"  
JOINS W/ STRAIGHT  
PIECES TO FORM  
OUTSIDE CORNERS.

**NOTES:**

1. PRECAST UNITS ARE INDIVIDUALLY HAND CAST. LENGTHS ARE APPROXIMATE. SOME VARIATIONS ARE EXPECTED.
2. INSTALLATION TO BE COMPLETED IN ACCORDANCE WITH GENERALLY ACCEPTED MASONRY PRACTICE.
3. STIPPLE FINISH ON TOP WITH SMOOTH BULLNOSE. SANDBLAST FINISH AVAILABLE.
4. PRECAST UNITS MAY BE CUT TO FIT FIELD CONDITIONS.

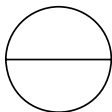

## CLASSIC ENTRY STEP DETAILS

SCALE: N.T.S.





## CLASSIC ENTRY STEP DETAILS

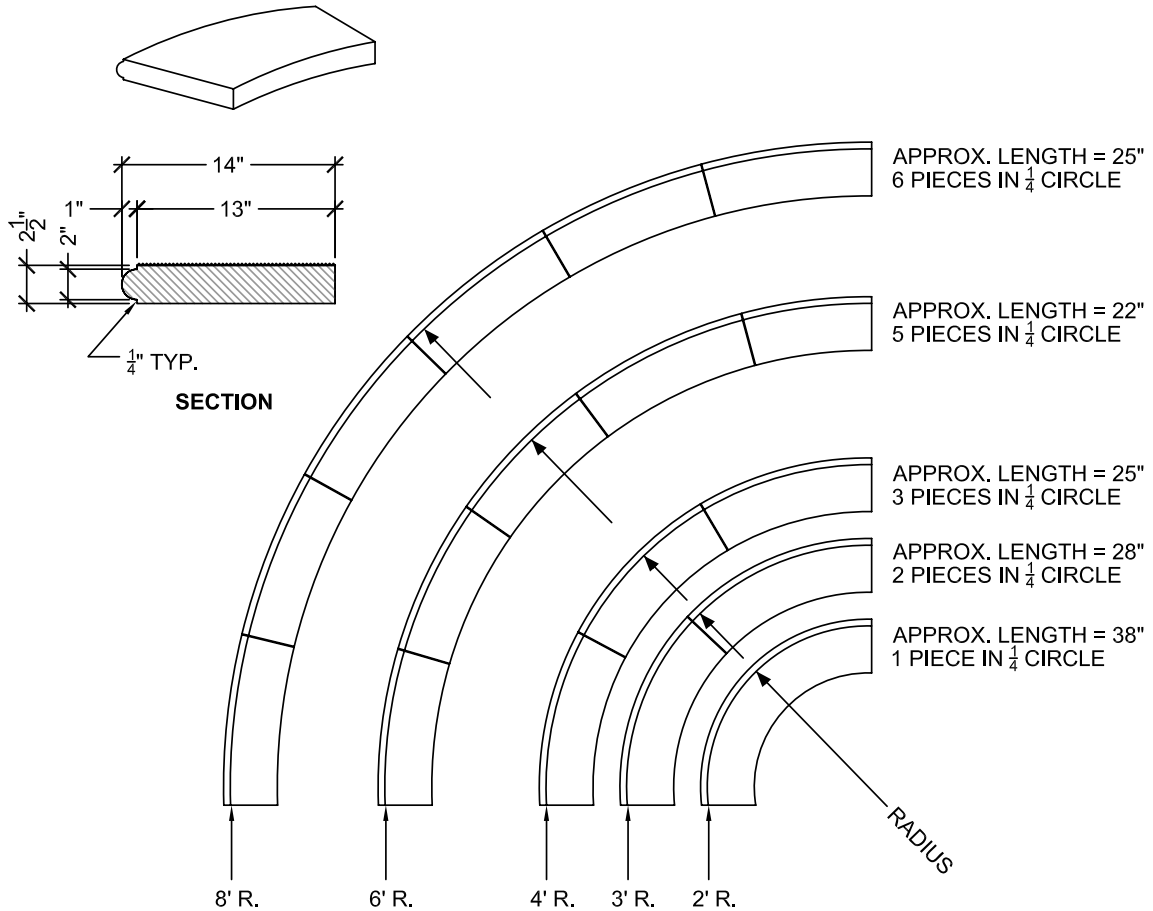

**NOTES:**

1. PRECAST UNITS ARE INDIVIDUALLY HAND CAST. LENGTHS ARE APPROXIMATE. SOME VARIATIONS ARE EXPECTED.
2. INSTALLATION TO BE COMPLETED IN ACCORDANCE WITH GENERALLY ACCEPTED MASONRY PRACTICE.
3. STIPPLE FINISH ON TOP WITH SMOOTH BULLNOSE. SANDBLAST FINISH AVAILABLE.
4. PRECAST UNITS MAY BE CUT TO FIT FIELD CONDITIONS.

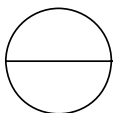

### CLASSIC ENTRY STEP OUTSIDE RADIUS

SCALE: N.T.S.





## CLASSIC ENTRY STEP DETAILS

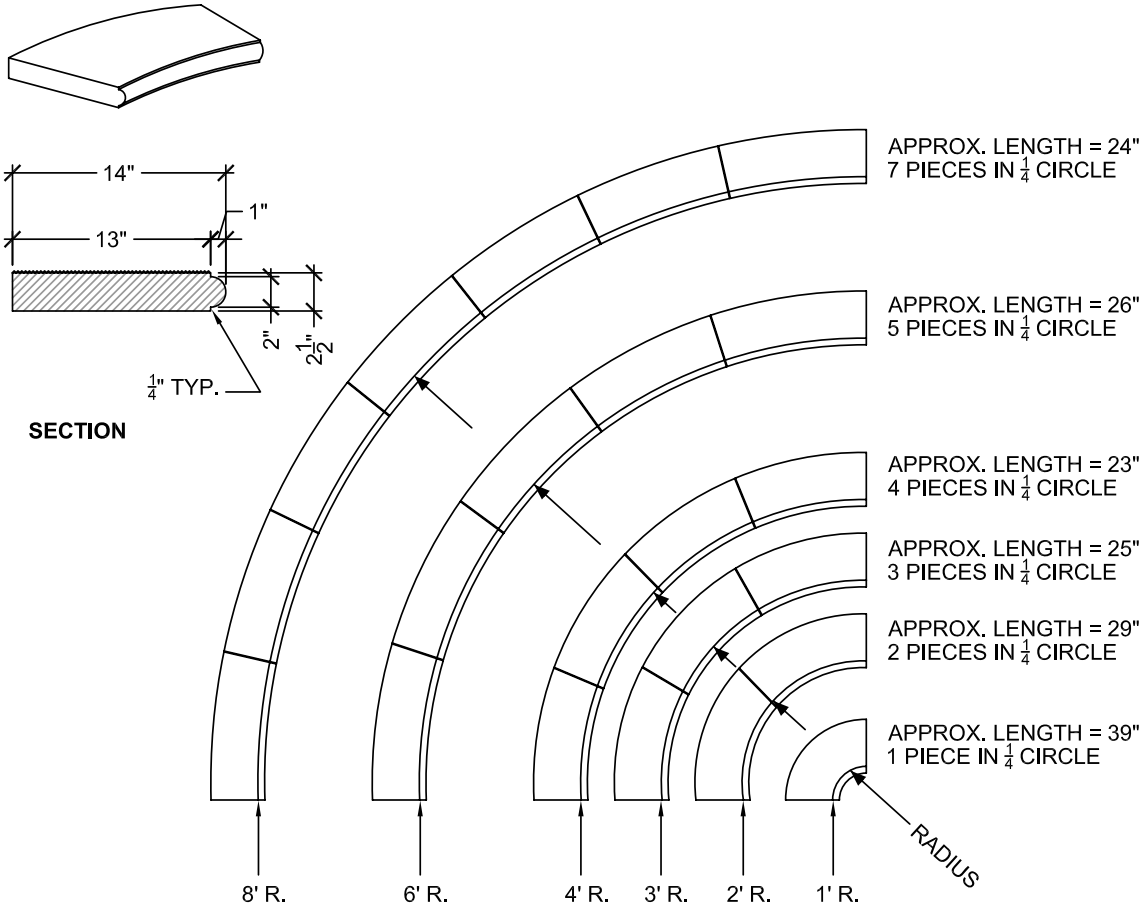

**NOTES:**

1. PRECAST UNITS ARE INDIVIDUALLY HAND CAST. LENGTHS ARE APPROXIMATE. SOME VARIATIONS ARE EXPECTED.
2. INSTALLATION TO BE COMPLETED IN ACCORDANCE WITH GENERALLY ACCEPTED MASONRY PRACTICE.
3. STIPPLE FINISH ON TOP WITH SMOOTH BULLNOSE. SANDBLAST FINISH AVAILABLE.
4. PRECAST UNITS MAY BE CUT TO FIT FIELD CONDITIONS.

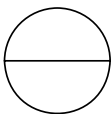

## CLASSIC ENTRY STEP INSIDE RADIUS

SCALE: N.T.S.





## SONORASTONE® ENTRY STEP DETAILS

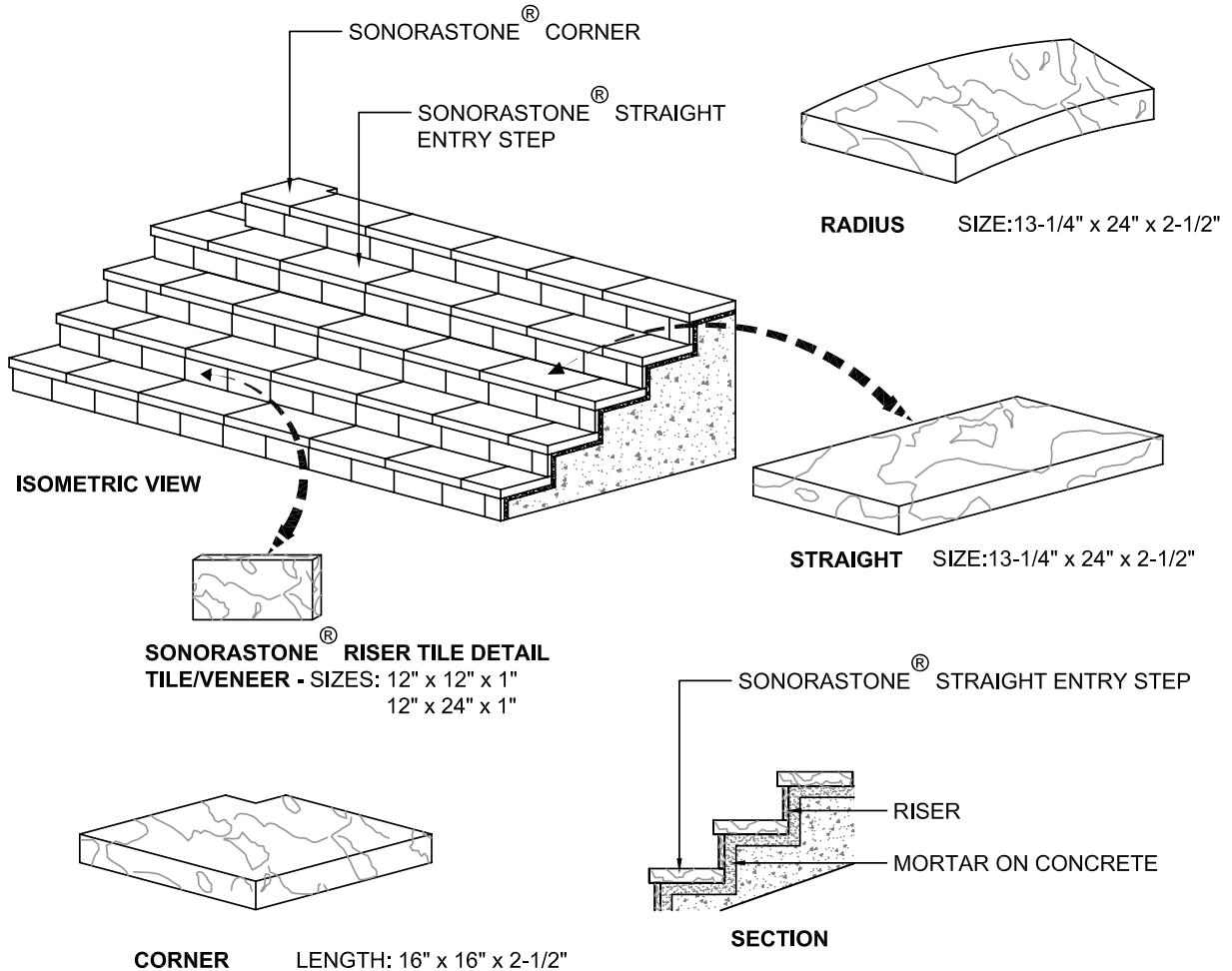

**NOTES:**

1. PRECAST UNITS ARE INDIVIDUALLY HAND CAST. LENGTHS ARE APPROXIMATE. SOME VARIATIONS ARE EXPECTED.
2. INSTALLATION TO BE COMPLETED IN ACCORDANCE WITH GENERALLY ACCEPTED MASONRY PRACTICES.
3. SONORASTONE® FINISH ON TOP AND SIDES.
4. PRECAST UNITS MAY BE CUT TO FIT FIELD CONDITIONS.

SONORASTONE® ENTRY STEP GENERAL DETAILS

SCALE: N.T.S.





## SONORASTONE® ENTRY STEP DETAILS

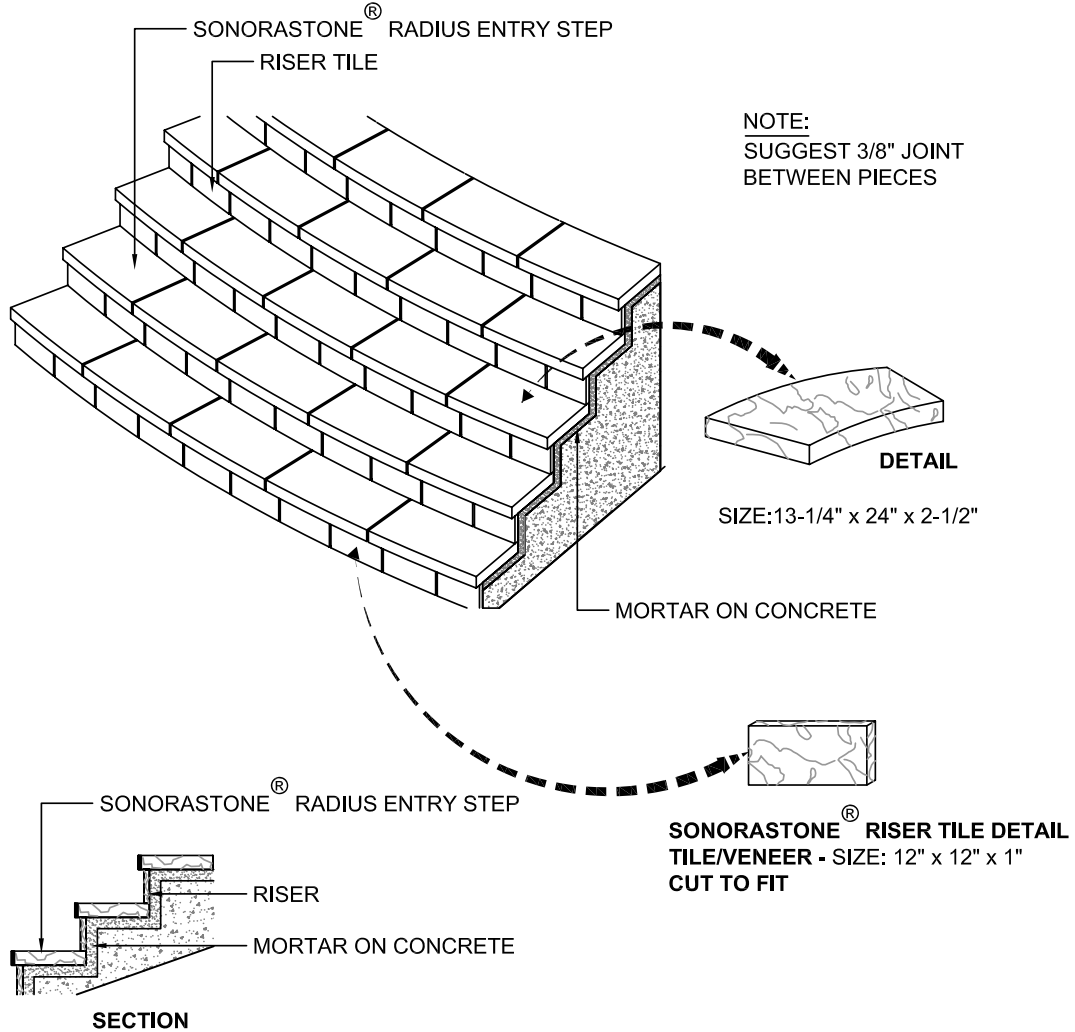

**NOTES:**

1. PRECAST UNITS ARE INDIVIDUALLY HAND CAST. LENGTHS ARE APPROXIMATE. SOME VARIATIONS ARE EXPECTED.
2. INSTALLATION TO BE COMPLETED IN ACCORDANCE WITH GENERALLY ACCEPTED MASONRY PRACTICES.
3. SONORASTONE® FINISH ON TOP AND SIDES.
4. PRECAST UNITS MAY BE CUT TO FIT FIELD CONDITIONS.

## SONORASTONE® ENTRY STEP RADIUS PIECE DETAILS

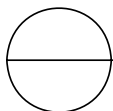

SCALE: N.T.S.





## SONORASTONE® ENTRY STEP DETAILS

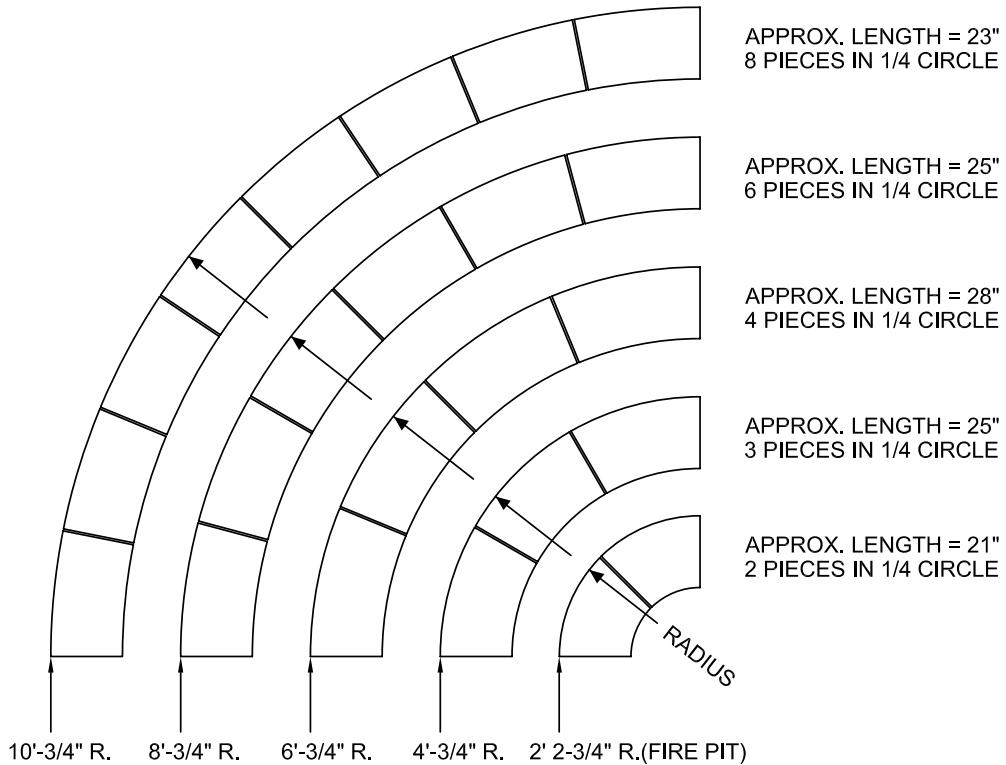
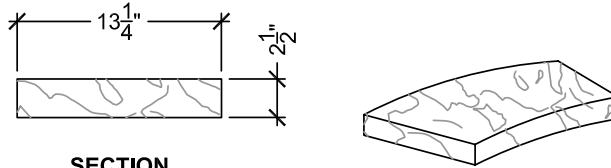

**NOTES:**

1. PRECAST UNITS ARE INDIVIDUALLY HAND CAST. LENGTHS ARE APPROXIMATE. SOME VARIATIONS ARE EXPECTED.
2. INSTALLATION TO BE COMPLETED IN ACCORDANCE WITH GENERALLY ACCEPTED MASONRY PRACTICES.
3. SONORASTONE® FINISH ON TOP AND SIDES.
4. PRECAST UNITS MAY BE CUT TO FIT FIELD CONDITIONS.

